

SECTION A
SCALE 1 : 2

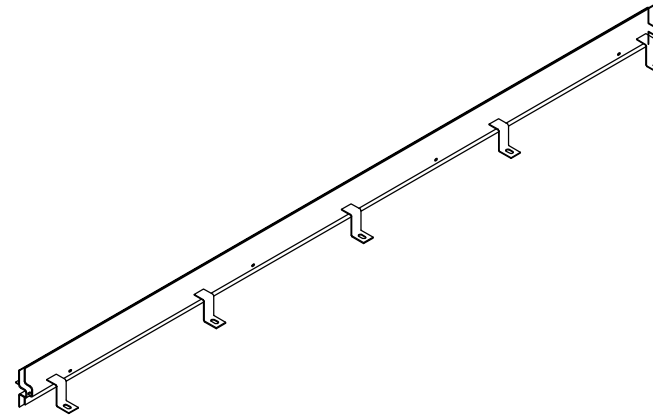

Available materials: Steel Electrogalvanised steel Stainless steel	<small>PROPRIETARY AND CONFIDENTIAL</small> <small>THE INFORMATION CONTAINED IN THIS DRAWING IS THE SOLE PROPERTY OF HCJ. ANY REPRODUCTION IN PART OR AS A WHOLE WITHOUT THE WRITTEN PERMISSION OF HCJ IS PROHIBITED.</small>		Hengelhoeftstraat 158 3600 Genk, Belgium Tel. 0032 89 32 39 82 Fax. 0032 89 32 39 88 www.hcjoints.eu e-mail info@hcjoints.be
	TITLE: height 100 mm x 3 mm		WEIGHT/PC Kg
Hcj reserves the right to alter the products without notice	SIZE: C	DWG. NO.: miniomega	REV
	<small>ALL DIMENSIONS ARE IN MM</small>		<small>DO NOT SCALE DRAWING</small>
SCALE: 2:1		SHEET 1 OF 1	